



S E R V E R

SERVE BETTER™

CerealServ™

CEREAL DISPENSERS

MODELS:

DFD-C

DFD-C-ST

DFD-C-2

DFD-C-3

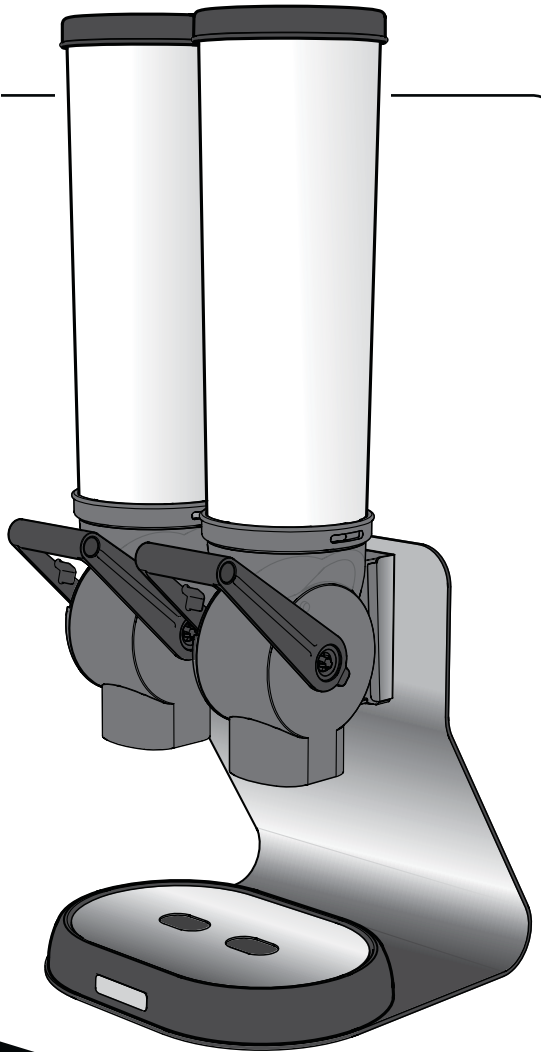

Thank You

...for purchasing our CerealServ™ Dispensers. Eliminate the waste of single-serve cereal packages. These robust dispensers easily dispense favorites with an ADA compliant handle – no twisting wrist motion or tight grasping required.

*Configurations vary.
See page 3.*

SERVE CEREAL — BETTER

SAFETY



According to food and safety regulations, most foods must be stored and/or served at certain temperatures or they could become hazardous. Check with local food and safety regulators for specific guidelines.

Be aware of the product you are serving and the temperature the product is required to maintain. Server Products, Inc. cannot be responsible for the serving of potentially hazardous product.



NSF International listed.



Does not require a twisting wrist motion or tight grasping to dispense.

IMPORTANT

Clean, rinse, sanitize, and dry parts daily or regularly to comply with local sanitization requirements.

CAUTION

Keep fingers clear of all moving parts to prevent operator injury when dispensing product, during cleaning, assembly and disassembly.

CLEANING

1 CLEAN

After disassembling, clean all washable parts with soap and hot water.

2 RINSE

fully with clear water.

3 SANITIZE

all parts according to local sanitization requirements. All parts in contact with food must be sanitized.

4 AIR DRY

all parts fully.



YES!

Use dishwashing soap and hot water

Care of Countertop Stand & Drip Tray:

- External surfaces may be wiped clean with a clean damp cloth.
- Glass and surface cleaners approved for use in food contact areas may be used.
- Do not use abrasive, caustic or ammonia based cleansers.
- Do not use metal scrapers or cleaning pads that could scratch surfaces.

**Plastic Drip Tray:
HAND WASH ONLY**

CONFIGURATIONS

WALL-MOUNTED

DFD-C-2 | *DFD-C-3*

1.5 LITER DISPENSERS

88930 Double with mounting bracket

88950 Triple with mounting bracket

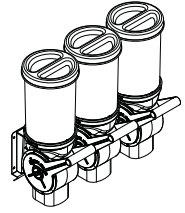
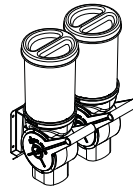

3 LITER DISPENSERS

88940 Double with mounting bracket

88960 Triple with mounting bracket

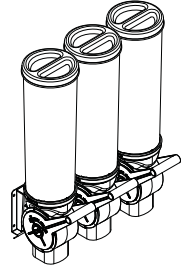
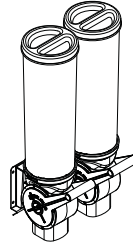

COUNTERTOP

DFD-C-ST

1.5 LITER DISPENSERS

88890 Double with countertop stand

88910 Triple with countertop stand

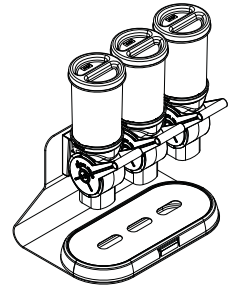
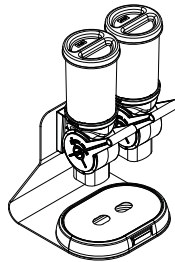

3 LITER DISPENSERS

88900 Double with countertop stand

88920 Triple with countertop stand

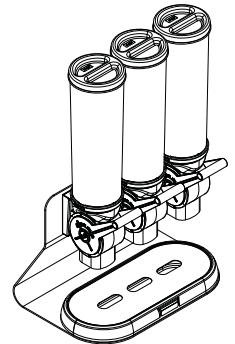
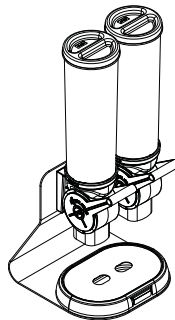

ASSEMBLY



PRACTICE SAFETY. WASH ALL PARTS PROPERLY BEFORE USE. See page 2.

1 ATTACH FRICTION PAD

Insert four triangular tabs on friction pad into matching slots in cylinder.

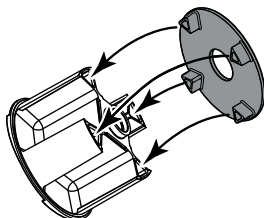

2 INSTALL CYLINDER

Slide cylinder into the opening of dispenser body.

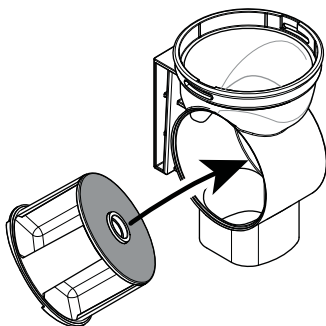

3 INSTALL HANDLE ONTO BODY & CYLINDER

Slide handle over both sides of body and cylinder. Snap handle centers into holes on each side.

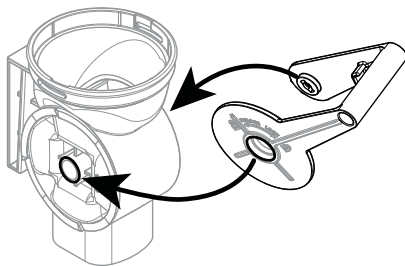
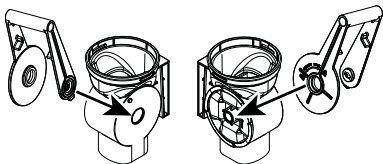

4 INSTALL PIVOT PIN

Slide pivot pin into center hole on left side of handle.

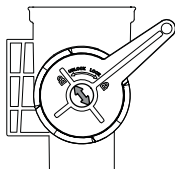

Align arrow on the pin with the unlock position.

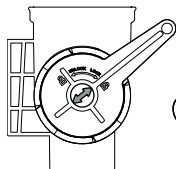

Push pin in. Rotate to the locked position.

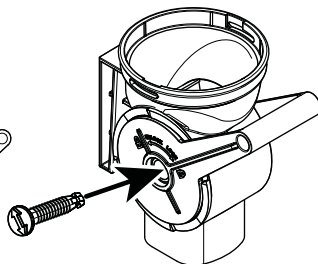

5 ADD HOPPER TUBE

Insert tabs of hopper into slots on body.
Turn clockwise until secure.
Hopper snaps into place.



6 FILL UNIT WITH CEREAL

7 PUT THE LID ON TOP OF HOPPER

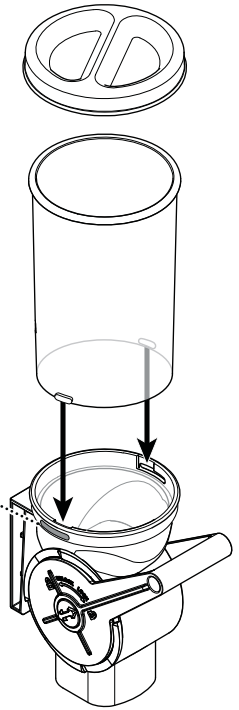

MOUNTING

COUNTERTOP STAND

Slide dispenser into bracket of stand.

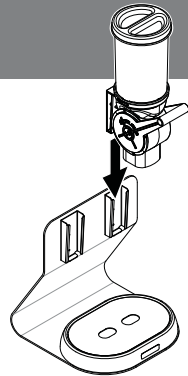

WALL BRACKET INSTALLATION

YOU WILL NEED:

- Screwdriver
- (4) screws &
- (4) anchor bolts (if needed)



Select wall location or sturdy vertical surface for mounting.

Determine proper mounting hardware you will need to supply.

Secure bracket to wall stud(s), anchor bolts in wall, or sturdy vertical surface.

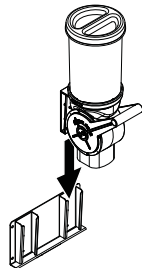

USE

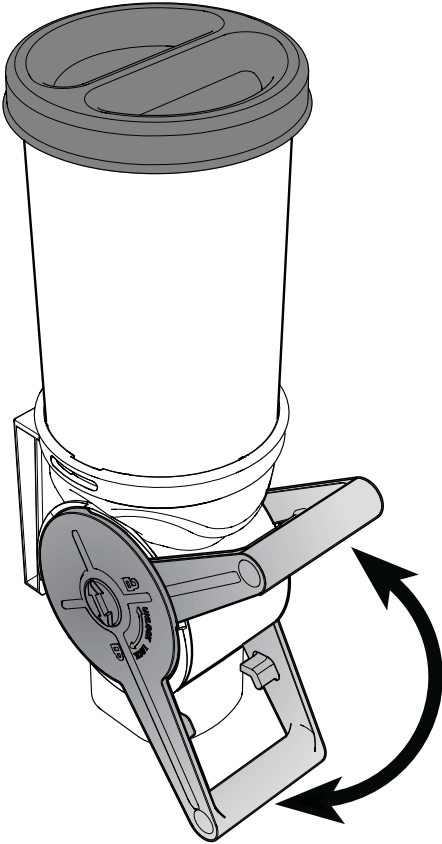

For cylinder to advance and serve a portion, the handle must travel its full range of motion up and down.

SWING HANDLE UP FULLY

to load the cylinder chamber.

Handle **CLICKS** above side notch.

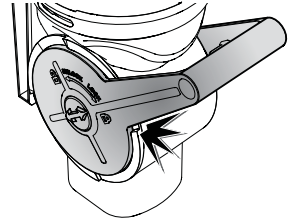

SWING HANDLE DOWN FULLY

to dispense the serving.

Angled tabs inside handle **TAP** bottom.

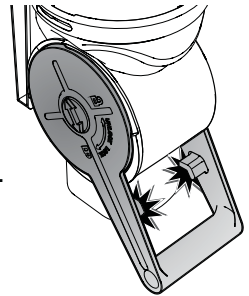

TROUBLESHOOTING

Make sure the **handle** is installed correctly with the pivot pin locked in place.

Make sure the **friction pad and cylinder** are properly installed.

Make sure there is enough product remaining to dispense and that the product is free to move to the bottom.

Make sure you are dispensing the right kind of product. The CerealServ™ dispenser is designed for free-flowing foods. Don't use it for sticky, gummy or powdered ingredients.

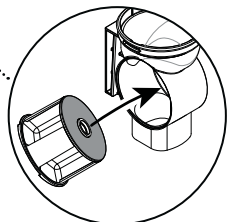
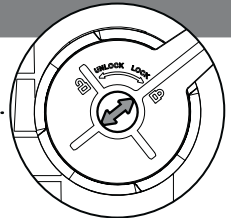

DISASSEMBLY

1 REMOVE LID

2 EMPTY INGREDIENTS FROM UNIT

3 REMOVE HOPPER

Turn hopper counterclockwise to remove tabs from slots on body.

4 REMOVE PIVOT PIN

Rotate pin to the unlock position and take it out.

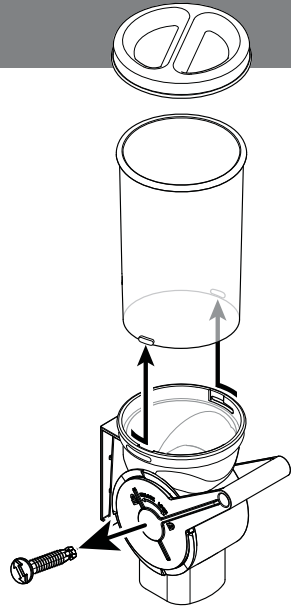

5 REMOVE HANDLE

Lift handle upward to the position just before it would click. This makes the handle easier to remove.

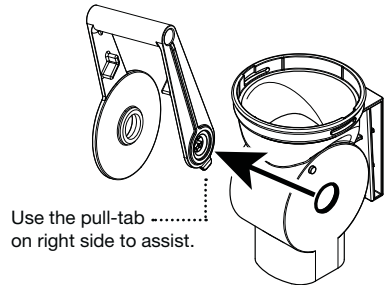

6 REMOVE CYLINDER

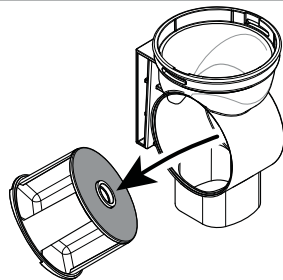

7 REMOVE FRICTION PAD

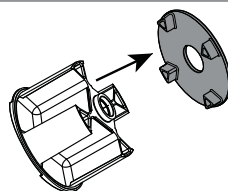

CEREALSERV™

MOUNTING PARTS

DOUBLE WALL MOUNTING BRACKET
89003

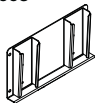

TRIPLE WALL MOUNTING BRACKET
89005

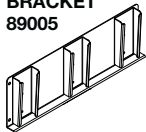

DOUBLE CEREALSERV™ STAND
88918

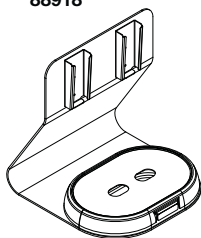

INCLUDES
DRIP TRAY ASSEMBLY
89014 &
RUBBER FEET ○
84393

TRIPLE CEREALSERV™ STAND
88919

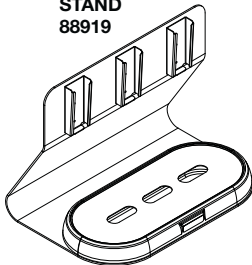

INCLUDES
DRIP TRAY ASSEMBLY
89015 &
RUBBER FEET ○
84393

DISPENSER PARTS

LID
89002



HOPPER TUBE, 1.5 LITER
88963

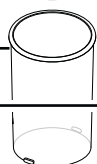

HOPPER TUBE, 3 LITER
89001



HANDLE
88754



BODY
88964



PIVOT PIN
88776

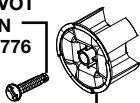

CYLINDER
88753



FRICITION PAD
88761



SERVER PRODUCTS LIMITED WARRANTY

2
YEAR
WARRANTY

Server Products equipment is backed by a two-year limited warranty against defects in materials and workmanship.

For complete warranty information go to:

www.Server-Products.com

GENERAL SERVICE, REPAIR OR RETURNS

Before sending any item to Server Products for service, repair, or return, contact Server Products customer service to request a **Return Authorization Number**. Merchandise must be sent to Server Products with this number. Service is extremely prompt. Typically, units are repaired and ship out within 48 hours of receipt.

Merchandise being returned for credit must be in new and unused condition and not more than 90 days old and will be subject to a 20% restocking charge.

NEED HELP?

Server Products Inc.

3601 Pleasant Hill Road
Richfield, WI 53076 USA



262.628.5600 | 800.558.8722



SPSALES@SERVER-PRODUCTS.COM

Please be prepared with your **Model** and **Series Number**. These are found on the side of the dispenser body and the stand or bracket.

Certain components are also marked with individual **Part Numbers**.